

IN-LINE BIDIRECTIONAL DETONATION and DEFLAGRATION FLAME ARRESTER

Typ: DAG-A7-B-IIB-050

Certificate: **IBExU12ATEX2031 X** EN ISO 16852 

PIPE CONNECTION		
FLANGED CONNECTION	50 - DIN 2631 - PN6*	
* According to the customers' request DIN 2632 PN10 or DIN 2633 PN16		
THREAD CONNECTION	DN 50 - 2"	
MATERIAL OF CASING, CONNECTING FLANGES AND CONNECTION MATERIAL		
ČSN 11 373	DIN 1.0036	S235JRG1
ČSN 17 240	DIN 1.4301	X5CrNi18-10
ČSN 17 348	DIN 1.4571	X6CrNiMoTi17-12-2

MATERIAL QUENCHING ELEMENT	DIN 1.4571 - X6CrNiMoTi17-12-2
SEALING	CS1310 th. 2 mm (expanded graphite)
CORROSION PROTECTION	Zink, Komaxit RAL 2004
ARRESTER WEIGHT	ca. 15 kg
MAXIMUM OPERATING PRESSURE	1,1 bar
OPERATING TEMPERATURE RANGE	-20 °C... +60 °C
NAMEPLATE	stainless metal sheet
EXPLOSION CLASS	IIB

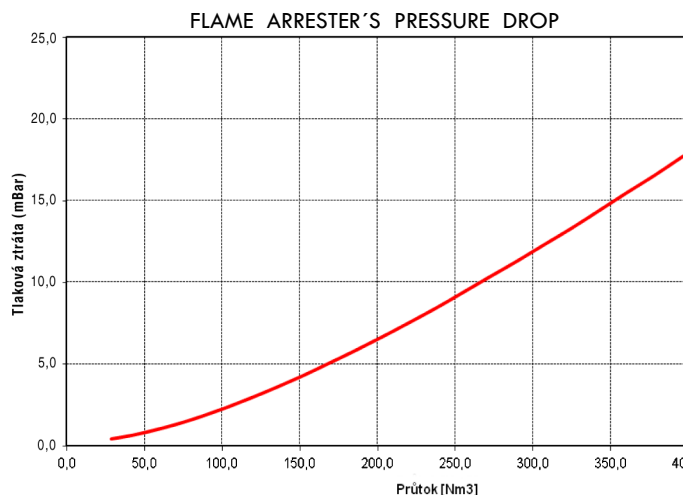
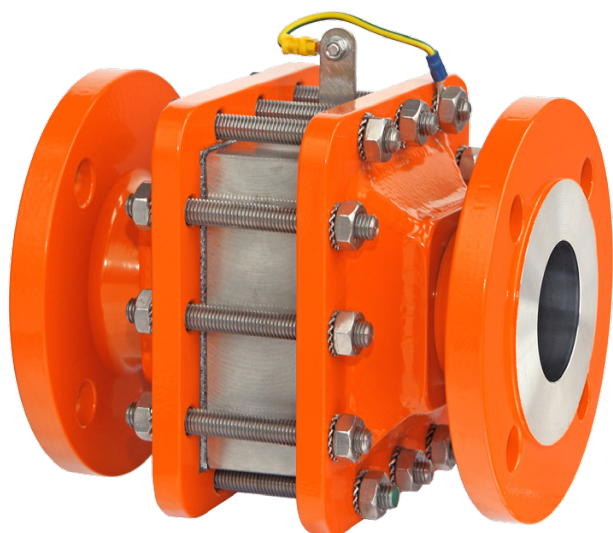

SafExty NExus®

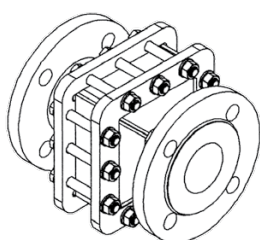

Flanged connection

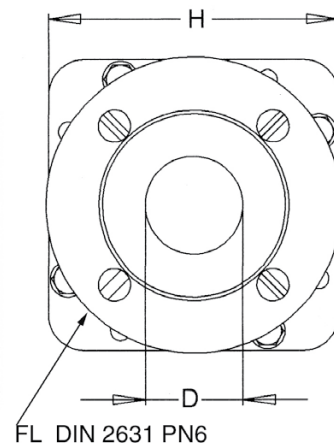
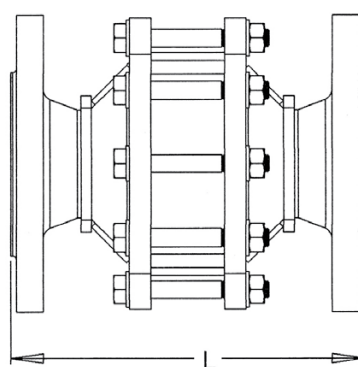

ROZMĚRY - ABMESSUNGEN DIMENSIONS

D	DN	50
H	[mm]	162
L	[mm]	250
L1	[mm]	190
L3	[mm]	25
FL	DIN 2631	PN6
G"	[inch]	2"

Technické změny vyhrazeny - Technische Änderungen vorbehalten - Specifications subject to change without notice

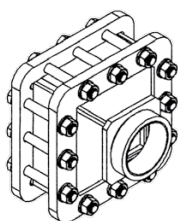

Thread connection

